

AB-72MHC

400W
405W
410W

144 (6x24) 158.75x79.375mm

Monocrystalline PV modules

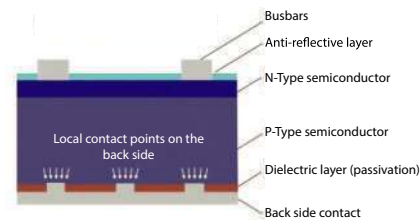
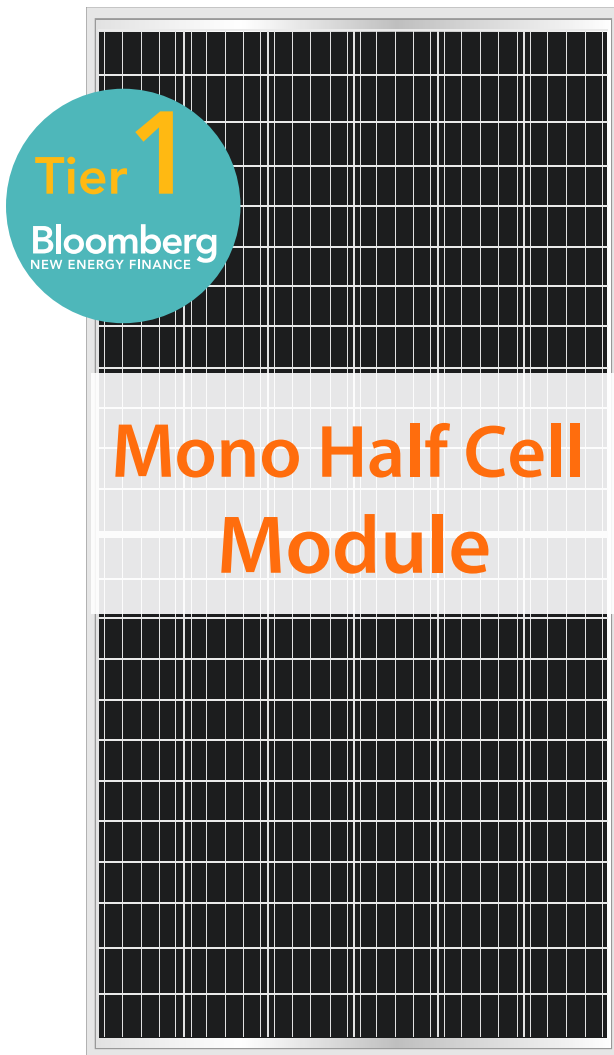

**Technology
PERC**

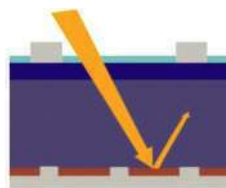

Increasing the absorption capacity of the photocell

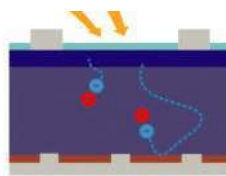

Reflection of electrons in the p-n transition zone

WHY ABI-SOLAR?

- Manufacturing and assembly of PV modules are performed only on East Asian enterprises from **Bloomberg Tier 1** list.
- PV modules are tested and demonstrate high reliability in various climatic conditions and in a wide range of insolation.
- High efficiency and return on investment guaranteed around the world.
- Modules certified by global testing facilities: IEC61215, IEC61730, CE, ROHS, TÜV.
- Manufacturing with international quality standards and environment management system: ISO9001 and ISO14001.
- Maximum power and performance at minimal price ensure fast return of investments.
- Compatibility with both on-grid and off-grid PV systems guaranteed.

INDUSTRY-LEADING WARRANTY BASED ON NOMINAL POWER

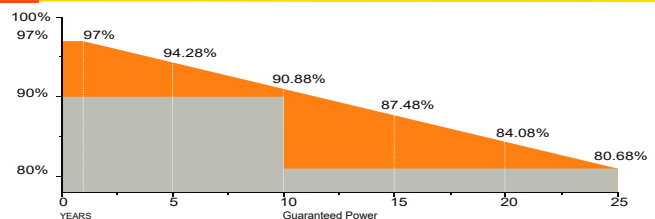

Based of nominal power (P_{nom})
25-year transferrable power output warranty:
95% - 5 years; 90% - 12 years; 85% - 18 years; 80% - 25 years
12-year material and workmanship

12 YEAR Manufacturing Warranty

12 YEAR WARRANTY 90% Power Output

25 YEAR WARRANTY 80% Power Output

MECHANICAL DRAWINGS

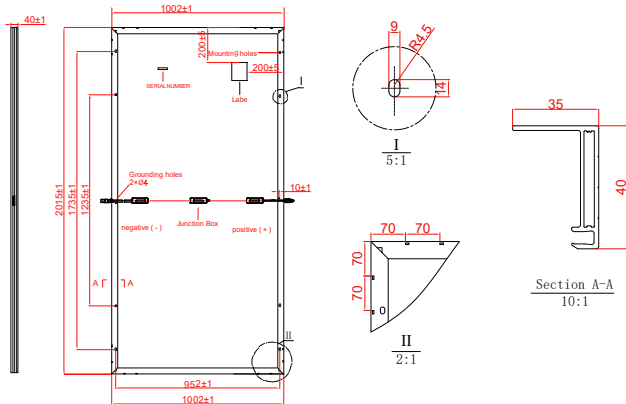

MECHANICAL SPECIFICATIONS

Cell type	Mono crystalline
Number of cell	144 (6x24) 158,75 x 79,375 mm
Dimensions (AxBxC)	2008x1002x40 mm
Weight	23kg
Front glass	3.2 mm AR coating tempered glass, low iron
Frame	Anodized aluminium alloy
Junction Box	IP68, 3 diodes
Connector	MC4 Compatible
Output cables	length: 1200 mm, 4.0 mm ²
Maximum snow load (IEC 61215)	5400Pa

ELECTRICAL CHARACTERISTICS (STC)

	AB400-72MHC	AB405-72MHC	AB410-72MHC
Maximum Power (Pmax)	400W	405W	410W
Shot Circuit Current (Isc)	10.10A	10.15A	10.20A
Open Circuit Voltage (Voc)	49.1V	49.4V	49.6V
Maximum Power Current (Imp)	9.62A	9.67A	9.72A
Maximum Power Voltage (Vmpp)	41.6V	41.9V	42.1V
Module Efficiency	19.81%	20.06%	20.28%
Power Tolerance	(0~+4.99 W)		
Maximum System Voltage	VDC 1000/1500V		
Maximum Series Fuse	20A		

NOCT

	AB400-72MHC	AB405-72MHC	AB410-72MHC
Maximum Power (Pmax)	293.9W	297.6W	301.3W
Shot Circuit Current (Isc)	8.13A	8.17A	8.21A
Open Circuit Voltage (Voc)	45.55V	45.83V	46.02V
Maximum Power Current (Imp)	7.68A	7.72A	7.76A
Maximum Power Voltage (Vmpp)	38.32V	38.60V	38.79V

STC irradiance: 1000 W/m² module temperature: +25 °C AM=1.5 NOCT irradiance: 800 W/m² module temperature: +20 °C AM=1.5

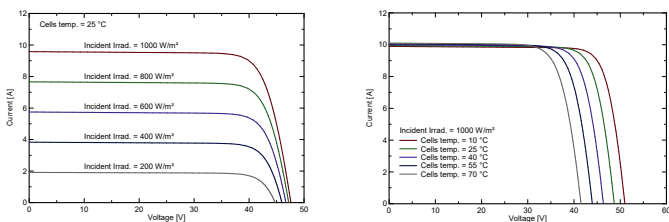

TEMPERATURE CHARACTERISTICS

Nominal Operating Cell Temperature (NOCT)	45±2 °C
Temperature Coefficient of Pmax	-0,38 %/°C
Temperature Coefficient of Voc	-0,28 %/°C
Temperature Coefficient of Isc	0.05 %/°C
Operating Temperature	-40~+85 °C

PACKING CONFIGURATION

	2015x 1002x 40 mm		
Container	20'GP	40'GP	40'HQ
Pieces per Pallet	27	27	27+6*
Pallets per Container	10	22	22
Pieces per Container	270	594	660

* (27+27+6)pieces per stack is the special package which only suits for container transport.

QUALIFICATIONS AND CERTIFICATES



Specifications are subject to change without prior notification